

Care Instructions

- This product is made from 100% recyclable PE Weave. Due to the nature of this material it may sag under direct sunlight but will return to its normal state upon cooling. To help reduce this occurrence we recommend using a parasol where possible
- Please keep sunlounger and cushions away from sources of extreme heat and naked flames
- Do not stand on this product
- Only recline on this product in the way it is designed. This product is only designed to be used with all four feet touching the ground
- Do not sit on the reclining section of the sunlounger, this could damage the product or cause it to tip
- We recommend cleaning this product periodically with warm, soapy water and a cloth or non-abrasive brush. Do not use harsh or abrasive chemicals.
- To keep your product looking its best, we would always recommend covering with a suitable furniture cover when not being used for longer periods. Throughout the winter months either bring indoors or cover as above. Failure to do so may invalidate your warranty.

Necessary Tools (Supplied)



You will find a pack within this box tied to a red ribbon which contains the fittings.







WARNING – the fittings pack contains **SMALL ITEMS** which are a potential choking hazard and should be kept away from children at all times.

Assembly Requirements

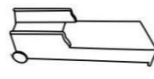
Number of people required to assemble	
Approximate Assembly time	20 minutes

Read this leaflet in full before commencing assembly.

Part List Supplied

A	SEAT		1	B	BACK		1	C	BOLT(M6X50L)		2
D	METAL WASHER (Ø6.5)		2	E	PLASTIC WASHER (8MM)		2	F	CAP(M6)		2
G	ALLEN KEY		1								

Assembly Instructions

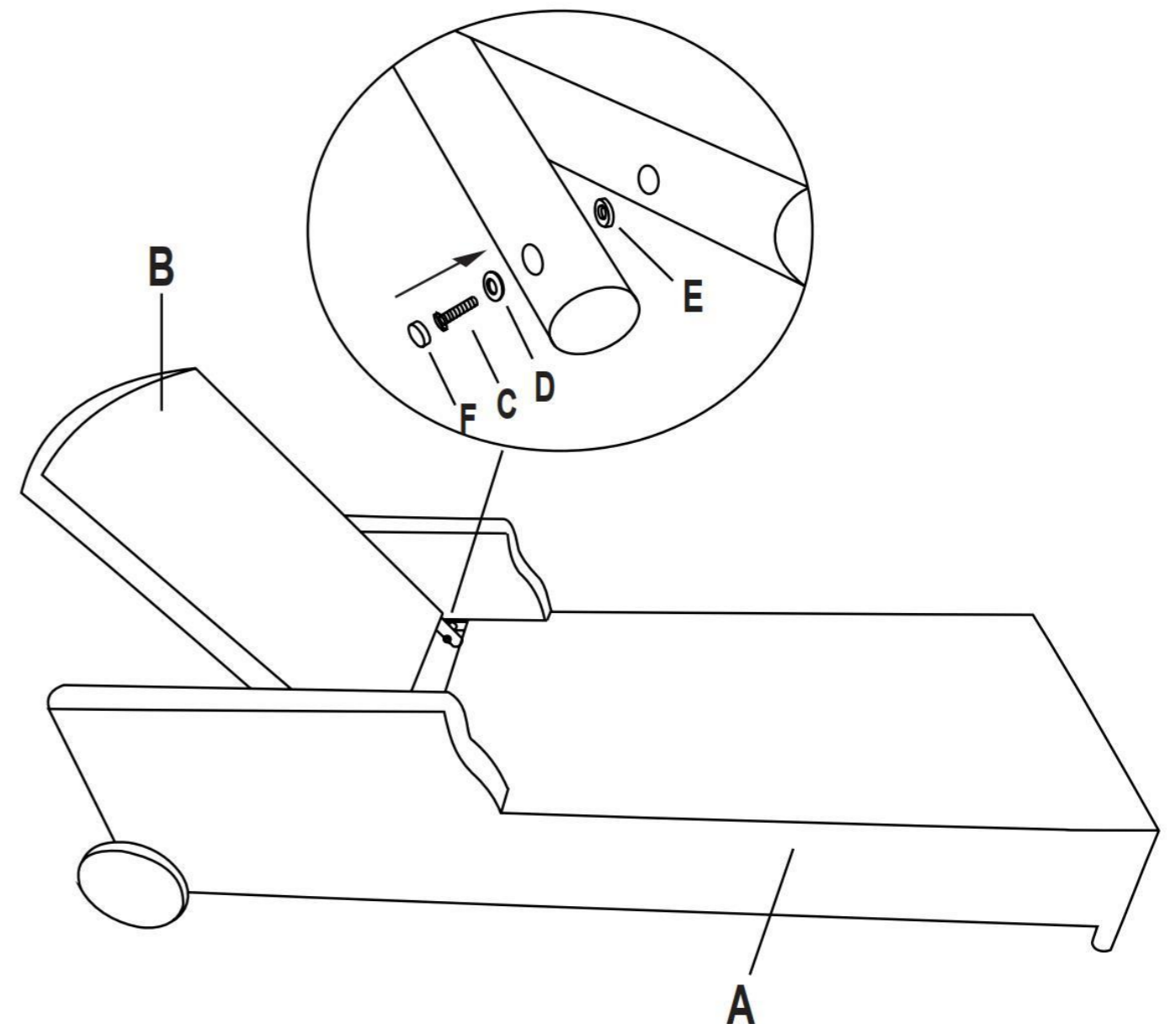

PLEASE ENSURE ALL FIXINGS ARE LEFT LOOSE DURING ASSEMBLY BUT ARE SECURELY TIGHTENED UPON COMPLETION.

General Warranty Conditions

The warranty applies to the original purchaser from the date of purchase and covers manufacturing faults and defects only. If an item should fail as a result of a manufacturing fault or defect under normal domestic use, the manufacturer at their discretion will repair, refinish or replace the failed item.

The manufacturer reserves the right to substitute failed items with a similar product should the model or colour no longer be available. Any replacement will be for the failed item only, not a complete set. The original warranty period is not extended in the event of a repair, refinish or replacements.

In the event of a failure, it is the customer's responsibility to return the item to the store of purchase along with a copy of the receipt. Warranty specifically excludes general wear and tear, rusting of steel components and parts, corrosion, commercial use and damage caused as a result of failure to observe reasonable care, maintenance and assembly instructions for both furniture and hardware.



ASSEMBLY AND CARE INSTRUCTIONS

Everley Deluxe Sunlounger and Cushion



**This is an important document.
Please retain for future reference.**

**Please keep your receipt of purchase. Please note we are unable
to process any warranty claim without proof of purchase.**